

HIGH-TEMPERATURE MONOBLOC AIR-TO-WATER HEAT PUMPS WITH INTEGRATED HYDRAULIC MODULE



- Hot water up to 65°C
- High energy efficiency level
- Hydraulic module with Class A circulator
- Superior reliability

61AF 014-019

Nominal heating capacity 14-20 kW

The AquaSnap high-temperature heat pump range was designed for commercial applications such as the heating of offices, apartments and hotels as well as domestic hot water production in new and refurbished buildings.

AQUASNAP
Heating

HEATING



CARRIER participates in the ECP programme for LCP/HP
Check ongoing validity of certificate:
www.eurovent-certification.com

FEATURES AND BENEFITS

Features

The main features of this product range are:

- **Energy savings**
The 61AF range is certified to the Eurovent energy efficiency class A with a coefficient of performance (COP) of over 4. This complies with the COP required by the Ecolabel certification.
- **Ease-of-installation**
The high-temperature AquaSnap heat pumps incorporate a hydraulic module with a variable speed pump, in option.
- **Easy integration**
The low noise levels of the 61AF heat pump and its very compact chassis reduce the noise disturbance from the unit.
- **Application flexibility**
The operating range allows outside temperatures down to -20°C and leaving water temperatures up to 65°C for domestic hot water applications.
- **Availability**
 - Intelligent unit control permits unit operation in extreme conditions, minimising unit shut-down times.
 - Hot water production at 65°C is available continuously.

Carrier quality is your guarantee for the safety and durability of the installation.

The high-temperature heat pump range incorporates the latest technological features:

- scroll compressors with vapour injection
- low-noise fans made of a composite material
- auto-adaptative microprocessor control
- electronic expansion valve
- variable speed pump.

The high-temperature AquaSnap heat pumps can be equipped with a hydraulic module that is integrated into the heat pump chassis, limiting the installation to straight-forward operations like the wiring and the connection of the hot water supply and return piping.

Quiet operation

- **Compressors**
 - Low-noise scroll compressors with low vibration level.
 - The compressor assembly is installed on an independent chassis and supported by anti-vibration mountings.
 - Dynamic suction and discharge piping supports, minimising vibration transmission (Carrier patent).
- **Evaporator section**
 - Vertical evaporator coils
 - Protection grilles on anti-vibration mountings to protect the heat exchanger against possible shocks.
 - Latest-generation low-noise Flying Bird fans are now even quieter and do not generate intrusive low-frequency noise.
 - Rigid fan installation for reduced start-up noise.

Easy and fast installation

- **Integrated hydraulic module (option)**
 - Variable speed water pump.
 - Water filter protects the water pump against circulating debris (option).
 - Overpressure valve, set to 3 bar for the 61AF 014 and to 4 bar for the 61AF 019.
 - Thermal insulation and frost protection down to -20°C, using an electric resistance heater.
- **Physical features**
 - The unit has a small footprint and a low height (1103 mm for the 61AF 014 and 1550 mm for the 61AF 019), allowing it to blend in with any architectural styles.
 - The unit is enclosed by easily removable panels, covering all components (except condensers and fans).
- **Simplified electrical connections**
 - Single power supply point with neutral.
 - Main disconnect switch with high trip capacity (standard only for 61AF 019).
 - Transformer for safe 24 V control circuit supply included.
- **Fast commissioning**
 - Systematic factory operation test before shipment.
 - Quick-test function for step-by-step verification of the instruments, electrical components and motors.

Economical operation

- **Seasonal heating performance optimized**
 - In accordance with standard EN 14825/2013 in average climate, the Seasonal Coefficient of performance (SCOP) reaches 2.83 for an energy label of A+.
 - The electronic expansion device (EXV) allows operation at a lower condensing pressure (COP optimisation).
 - Dynamic superheat management for better utilisation of the condenser surface.
 - Specific Free Defrost algorithm is present to optimise performance and comfort even during defrost period.
- **Reduced maintenance costs**
 - Maintenance-free scroll compressors with vapour injection.
 - Pro-Dialog+ control offers fast diagnosis of possible incidents and their history.

Environmental care

- **Non-ozone depleting R-407C refrigerant**
 - Chlorine-free refrigerant of the HFC group with zero ozone depletion potential.
 - Very efficient - ensures an increased energy efficiency ratio (COP).
- **Leak-tight refrigerant circuit**
 - Brazed refrigerant connections for increased leak-tightness.
 - Reduction of leaks due to elimination of capillary tubes (TXVs).
 - Verification of pressure transducers and temperature sensors without transferring refrigerant charge.

FEATURES AND BENEFITS

Superior reliability

- State-of-the-art concept
 - Cooperation with specialist laboratories and use of limit simulation tools (finite element calculations) for the design of the critical components, e.g. motor supports, suction/discharge piping etc.
- Auto-adaptive control
 - Control algorithm prevents excessive compressor cycling.
- Exceptional endurance tests
 - Corrosion resistance tests in salt mist in the laboratory.
 - Accelerated ageing test on components that are submitted to continuous operation: compressor piping, fan supports.
 - Transport simulation test in the laboratory on a vibrating table.

Pro-Dialog+ control

Pro-Dialog+ combines intelligence with operating simplicity. The control constantly monitors all machine parameters and precisely manages the operation of compressors, expansion devices, fans and of the condenser water pump for optimum energy efficiency.

- Energy management
 - Seven-day internal time schedule clock: permits unit on/off control and operation at a second set-point.
 - Set-point reset based on the outside air temperature or the return water temperature or on the water heat exchanger delta T.
 - Master/slave control of two heat pumps operating in parallel with operating time equalisation and automatic change-over in case of a unit fault (option).
 - Start/stop based on the outside air temperature.
- Ease-of-use
 - The new backlighted LCD interface includes a manual control potentiometer to ensure legibility under any lighting conditions.
 - The information is displayed clearly in English, French, German, Italian and Spanish (for other languages please consult Carrier).
 - The Pro-Dialog+ navigation uses intuitive tree-structure menus, similar to the Internet browsers. They are user-friendly and permit quick access to the principal operating parameters: number of compressors operating, suction/discharge pressure, compressor operating hours, set-point, air temperature, entering/leaving water temperature.
 - As standard the unit includes a board for the control of a boiler and four electric resistance heater stages.

Pro-Dialog+ operator interface



Remote operating mode with volt-free contacts (standard)

A simple two-wire communication bus between the RS485 port of the AquaSnap high-temperature heat pumps and the Carrier Comfort Network offers multiple remote control, monitoring and diagnostic possibilities.

Carrier offers a vast choice of control products, specially designed to control, manage and supervise the operation of a heating system. Please consult your Carrier representative for more information on these products.

- Start/stop: opening of this contact will shut down the heat pump.
- Dual set-point: closing of this contact activates a second heating set-point (example: unoccupied mode).
- Demand limit: closing of this contact limits the maximum heat pump capacity to a predefined value.
- User safety: this contact is connected in series with the water flow switch and can be used for any customer safety loop.
- Water pump control.
- Alert indication: this volt-free contact indicates the presence of a minor fault.
- Alarm indication: this volt-free contact indicates the presence of a major fault that has led to the shut-down of the refrigerant circuit.

Remote interface (accessory)

This accessory includes a box that can be mounted inside the building. The power supply is provided via a 220 V/24 V transformer supplied. This interface allows access to the same menus as the unit interface and can be installed up to 300 m from the 61AF unit.

TYPE KEY

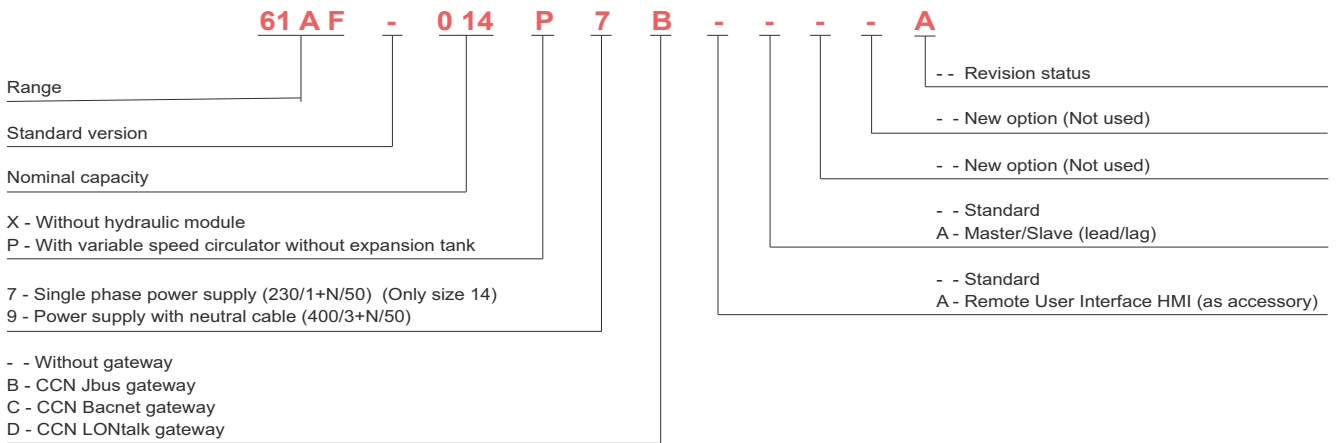

ACCESSORIES

Accessories	Description	Advantages	Use
Water filter	External water filter on the hydraulic module	Water pump protection against circulating debris	61AF 014-019

PHYSICAL DATA

61AF		014-7	014-9	019-9		
Heating						
Standard unit Full load performances *	HA1	Nominal capacity	kW	13,8	13,4	19,9
		COP	kW/kW	3,88	4,14	4,23
	HA2	Nominal capacity	kW	14,0	13,6	19,6
		COP	kW/kW	3,31	3,49	3,45
	HA3	Nominal capacity	kW	14,0	13,6	19,5
		COP	kW/kW	2,89	2,99	2,93
	HA4	Nominal capacity	kW	13,8	13,5	19,8
		COP	kW/kW	2,41	2,47	2,41
Seasonal energy efficiency**	HA1	SCOP _{30/35°C}	kWh/kWh	3,32	3,52	3,45
		η _{s heat} _{30/35°C}	%	130	138	135
	HA3	SCOP_{47/55°C}	kWh/kWh	2,89	3,02	3,05
		η_{s heat}_{47/55°C}	%	113	118	119
		P _{rated}	kW	14,00	13,33	14,12
		Energy labelling		A+	A+	A+
Operating weight⁽¹⁾						
Standard unit (without hydraulic kit)		kg	159	159	206	
Standard unit (plus hydraulic module option)		kg	169	169	216	
Sound levels						
Sound power level ⁽²⁾		dB(A)	71	71	72	
Sound pressure level at 10 m ⁽³⁾		dB(A)	40	40	41	
Dimensions						
Length		mm	1103	1103	1135	
Depth		mm	333	333	559	
Height		mm	1278	1278	1579	
Compressor		One, hermetic scroll, 48.3 r/s, one capacity stage				
Refrigerant		R-407C				
Charge	kg	4.0	4.0	8.0		
	teqCO ₂	7.1	7.1	14.2		
Capacity control		Pro-Dialog+				
Minimum capacity		%	100	100	100	
Condenser		Direct-expansion plate heat exchanger				
Water volume		l	3.7	3.7	3.9	
Max. water-side operating pressure with and without hydraulic module		kPa	300	300	400	
Fan		Two, axial twin-speed fans				
Total air flow (high speed)		l/s	2050	2050	2000	
Speed		r/s	11.7	11.7	14.5	
Evaporator		Grooved copper tubes and aluminium fins				
Pump		Variable speed pump				
Water connections with/without hydraulic module		Victaulic				
Connections		inch	1 female	1 female	1 male in/1-1/4 male out	
Outside diameter		mm	25	25	25 in/32 out	
Chassis paint colour		Colour code: RAL 7035				

* In accordance with standard EN14511-3:2013
 ** In accordance with standard EN14825:2013, average climate
 HA1 Heating mode conditions: Water heat exchanger water entering/leaving temperature 30°C/35°C, outside air temperature tdb/twb = 7°C db/6°C wb, evaporator fouling factor 0 m².K/W
 HA2 Heating mode conditions: Water heat exchanger water entering/leaving temperature 40°C/45°C, outside air temperature tdb/twb = 7°C db/6°C wb, evaporator fouling factor 0 m².K/W
 HA3 Heating mode conditions: Water heat exchanger water entering/leaving temperature 47°C/55°C, outside air temperature tdb/twb = 7°C db/6°C wb, evaporator fouling factor 0 m².K/W
 HA4 Heating mode conditions: Water heat exchanger water entering/leaving temperature 55°C/65°C, outside air temperature tdb/twb = 7°C db/6°C wb, evaporator fouling factor 0 m².K/W
 η_{s heat}_{30/35°C} & SCOP_{30/35°C} Applicable Ecodesign regulation: (EU) No 813/2013
 η_{s heat}_{47/55°C} & SCOP_{47/55°C} **Applicable Ecodesign regulation: (EU) No 813/2013**
 (1) Weight shown is a guideline only. Please refer to the unit nameplate
 (2) In dB ref=10-12 W, (A) weighting. Declared dualnumber noise emission values in accordance with ISO 4871 (with an associated uncertainty of +/-3dB(A)). Measured in accordance with ISO 9614-1 and certified by Eurovent.
 (3) In dB ref 20µPa, (A) weighting. Declared dualnumber noise emission values in accordance with ISO 4871 (with an associated uncertainty of +/-3dB(A)). For information, calculated from the sound power level Lw(A).



Eurovent certified values

ELECTRICAL DATA

61AF - standard unit		Without pump			With pump			
		014-7	014-9	019	014-7	014-9	019	
Power circuit								
Nominal power supply	V-ph-Hz	230-1-50	400-3-50	400-3-50	230-1-50	400-3-50	400-3-50	
Voltage range	V	207-253	360-440	360-440	207-253	360-440	360-440	
Control circuit supply		24 V, via internal transformer			24 V, via internal transformer			
Maximum start-up current (Un)*								
Standard unit	A	-	66	102	-	67	103	
Unit with electronic starter option	A	47	-	-	48	-	-	
Unit power factor at maximum capacity**		0.82	0.82	0.82	0.82	0.82	0.82	
Maximum unit power input**		kW	6.4	5.9	8.8	6.5	6.0	8.9
Nominal unit current draw***		A	22.9	7.9	12.4	24.0	9.0	13.5
Maximum unit current draw (Un)****		A	30.7	10.8	16.0	31.8	11.9	17.1
Maximum unit current draw (Un-10%)†		A	36.4	11.9	16.6	37.5	13.0	17.7

* Maximum instantaneous start-up current (maximum operating current of the compressor + fan current + locked rotor current of the compressor).

** Power input, compressor and fan, at the unit operating limits (saturated suction temperature 10°C, saturated condensing temperature 65°C) and nominal voltage of 400 V (data given on the unit nameplate).

*** Standardised Eurovent conditions: condenser entering/leaving water temperature = 40°C/45°C, outside air temperature db/wb = 7°C/6°C.

**** Maximum unit operating current at maximum unit power input and 400 V (values given on the unit nameplate).

† Maximum unit operating current at maximum unit power input and 360 V.

Electrical data and operating conditions notes:

- 61AF 014-019 units have a single power connection point located immediately upstream of the main disconnect switch.
- The control box includes the following standard features:
 - a main disconnect switch (size 019 only),
 - starter and motor protection devices for the compressor, the fan and the pump,
 - the control devices.
- Field connections:
All connections to the system and the electrical installations must be in full accordance with all applicable local codes.
- The Carrier 61AF units are designed and built to ensure conformance with these codes. The recommendations of European standard EN 60204-1 (machine safety - electrical machine components - part 1: general regulations - corresponds to IEC 60204-1) are specifically taken into account, when designing the electrical equipment.

Notes:

- Generally the recommendations of IEC 60364 are accepted as compliance with the requirements of the installation directives. Conformance with EN 60204-1 is the best means of ensuring compliance with the Machinery Directive § 1.5.1.
- Annex B of EN 60204-1 describes the electrical characteristics used for the operation of the machines.

• The operating environment for the 61AF units is specified below:

1. Environment* - Environment as classified in EN 60721 (corresponds to IEC 60721):
 - outdoor installation*
 - ambient temperature range: -20°C to +40°C, class 4K4H
 - altitude: ≤ 2000 m
 - presence of hard solids, class 4S2 (no significant dust present)
 - presence of corrosive and polluting substances, class 4C2 (negligible)
2. Power supply frequency variation: ± 2 Hz.
3. The neutral (N) conductor must not be connected directly to the unit (if necessary use a transformer).
4. Overcurrent protection of the power supply conductors is not provided with the unit.
5. The factory-installed disconnect switch is of a type suitable for power interruption in accordance with EN 60947-3 (corresponds to IEC 60947-3)
6. The units are designed for connection to TN networks (IEC 60364). For IT networks the earth connection must not be at the network earth. Provide a local earth, consult competent local organisations to complete the electrical installation.

Caution: If particular aspects of an actual installation do not conform to the conditions described above, or if there are other conditions which should be considered, always contact your local Carrier representative.

* The required protection level for this class is IP43BW (according to reference document IEC 60529). All 61AF units are protected to IP44CW and fulfil this protection condition.

DIMENSIONS, MM

61AF 014 unit with and without hydraulic module

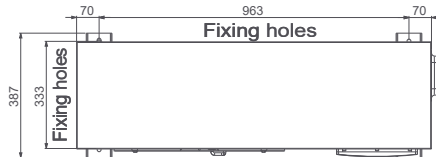
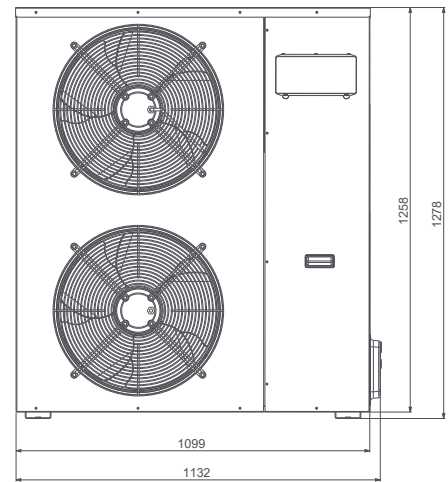
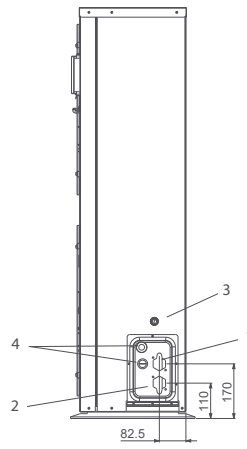
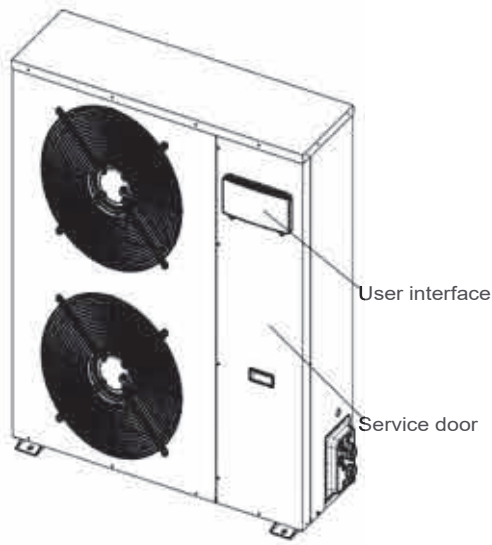

1. Water outlet
2. Water inlet
3. Relief valve outlet
4. Electrical connections

CLEARANCES, MM

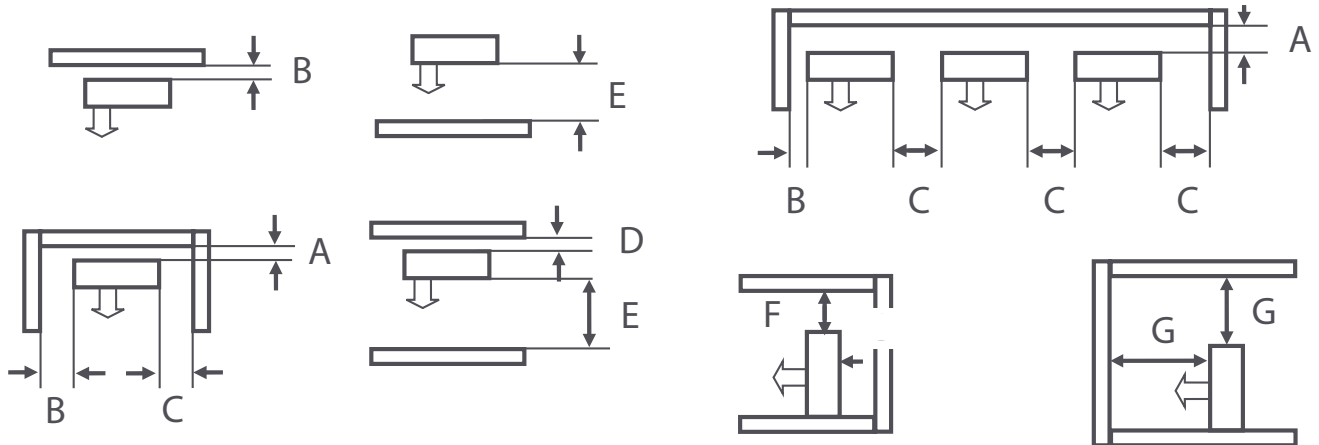

61AF 014	A	B	C	D	E	F	G
	100	250	500	100	670	400	670

DIMENSIONS, MM

61AF 019 unit with and without hydraulic module

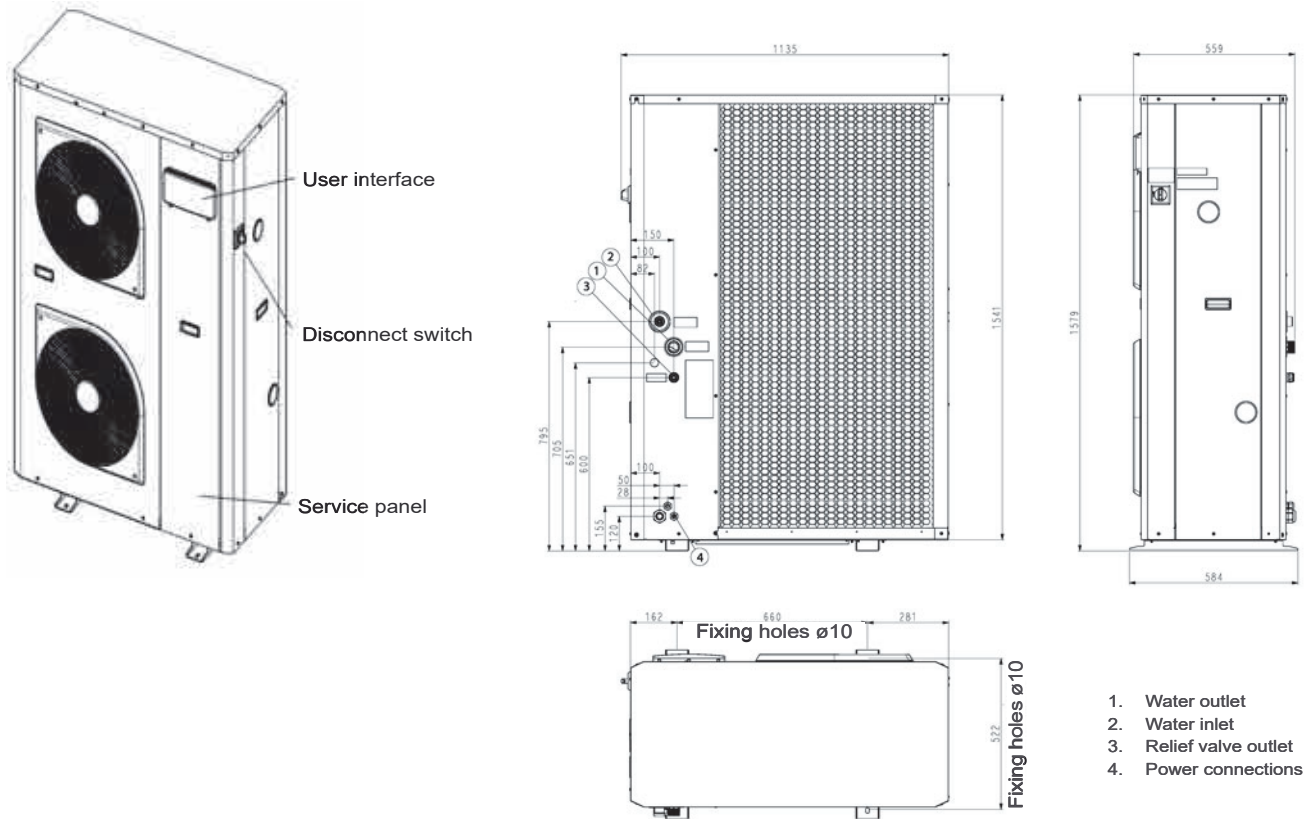

CLEARANCES, MM

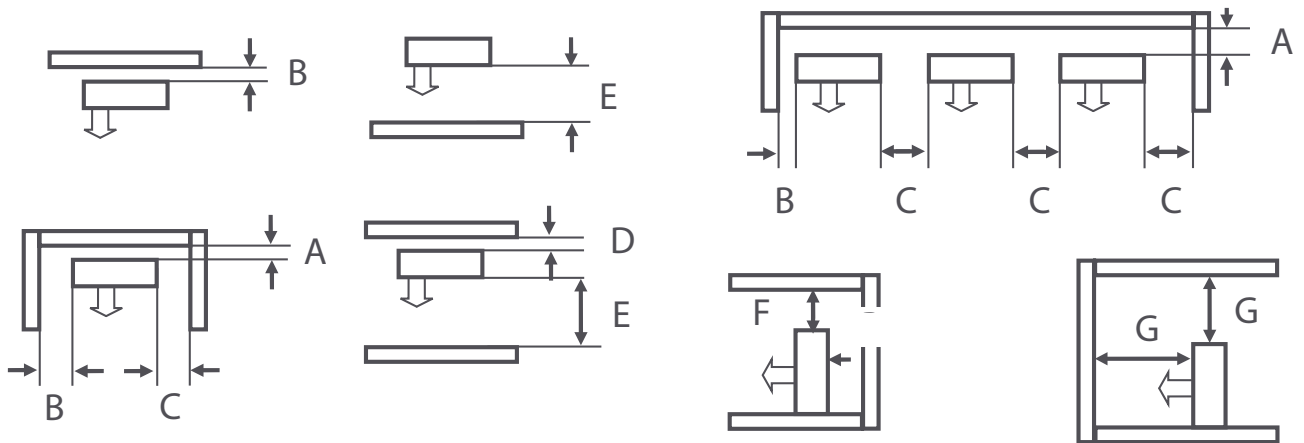

61AF 019	A	B	C	D	E	F	G
	300	200	400	200	700	500	1000